

Colour Television

Owner's Manual

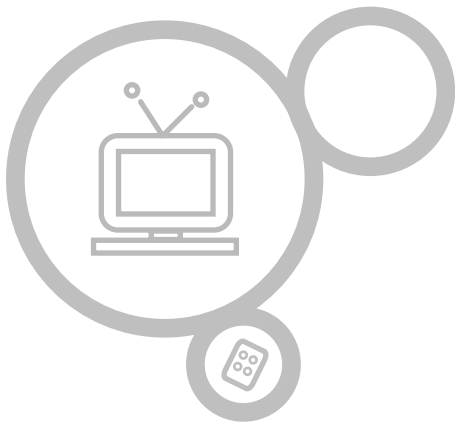

NLT-26HD1 / NLT-32HD1 / NLT-37HD1 / NLT-42HD1

Please read this manual carefully before operating your set.
Retain it for future reference.

See the label attached on the back cover and quote this information
to your dealer when you require service.

Contents

Installation	3	AVL (Auto Volume Leveler) SPDIF Format (in digital mode only) Stereo/Dual/NICAM reception	
Location and function of controls	4-7		
Remote control handset			
Battery installation			
Front panel			
Back panel			
Connection to External equipment	8-12		
Basic operation	13		
On and Off / Programme selection			
Volume adjustment			
On screen language selection (option)			
On screen menus	14		
Menu selection			
Setting up TV stations	15-22		
Auto programme tuning			
Manual programme tuning (in analogue mode only)			
Programme edit (in analogue mode only)			
Calling the programme table (in analogue mode only)			
DTV Info (in digital mode only)			
Rating Setup (in digital mode only)			
Rating menu options (in digital mode only)			
Set password (in digital mode only)			
Picture Menu	23-25		
CSM (Colour Status Memory)			
PSM (Picture Status Memory)			
Manual Picture Control			
Picture Format			
Sound Menu	26-29		
SSM (Sound Status Memory)			
Balance			
			30-33
		Time Menu	
		Clock	
		On/Off Time	
		Auto sleep	
		Time Zone (in digital mode only)	
		Daylight Saving (in digital mode only)	
		Sleep timer	
		Setup Menu	34
		Audio Mode (in digital mode only)	
		Information / TV Guide (in digital mode only)	35
		Favourite / FAV. Add/Del (in digital mode only)	36
		RGB-PC Menu	37
		PC Setup	
		PIP (Picture-In-Picture) Feature	38-39
		Teletext (option)	40-41
		Displayable Monitor Specification	42
		Troubleshooting Check list	43
		Product Spec.	44-47
		NEC Service Centers	51

Power

This set operates on an AC mains supply, the voltage is as indicated on the label on the back cover. Never apply DC power to the set. In the event of thunderstorms or powercuts, please pull out the aerial and mains plugs.

Warning

- To prevent fire or shock hazard, do not expose the set to rain or moisture. Do not rub or strike the Active Matrix LCD with anything hard as this may scratch, mar, or damage the Active Matrix LCD permanently.
- The appliance is not intended for use by young children or infirm persons without supervision.
- Young children should be supervised to ensure that they do not play with the appliance.
- Avoid displaying fixed pattern in the monitor for long period of time to avoid image persistence.

Service

Never remove the back cover of the set as this can expose you to very high voltage and other hazards. If the set does not operate properly, unplug it and call your dealer.

Aerial

Connect the aerial cable to the socket marked 75 Ω on the back cover. For the best reception an outdoor aerial should be used.

Location

Position your set so that no bright light or sunlight falls directly onto the screen. Care should be taken not to expose the set to any unnecessary vibration, moisture, dust or heat.

Also ensure that the set is placed in a position to allow a free flow of air. Do not cover the ventilation openings on the back cover.

Cleaning

Unplug the set before cleaning the face of the LCD Screen. Dust the set by wiping the screen and the cabinet with a soft, clean cloth. If the screen requires additional cleaning, use a clean, damp cloth. Do not use liquid cleaners or aerosol cleaners.

The LCD panel is very high technology product with about million thin film transistors, giving you fine picture details, Occasionally, a few non-active pixels may appear on the screen as a fixed point of blue, green or red. please note that this does affect the performance of your product.

Location and function of controls

Remote control handset

- All the functions can be controlled with the remote control handset.
- Some functions can also be adjusted with the buttons on the front panel of the set.
- Before you use the remote control handset, please install the batteries.

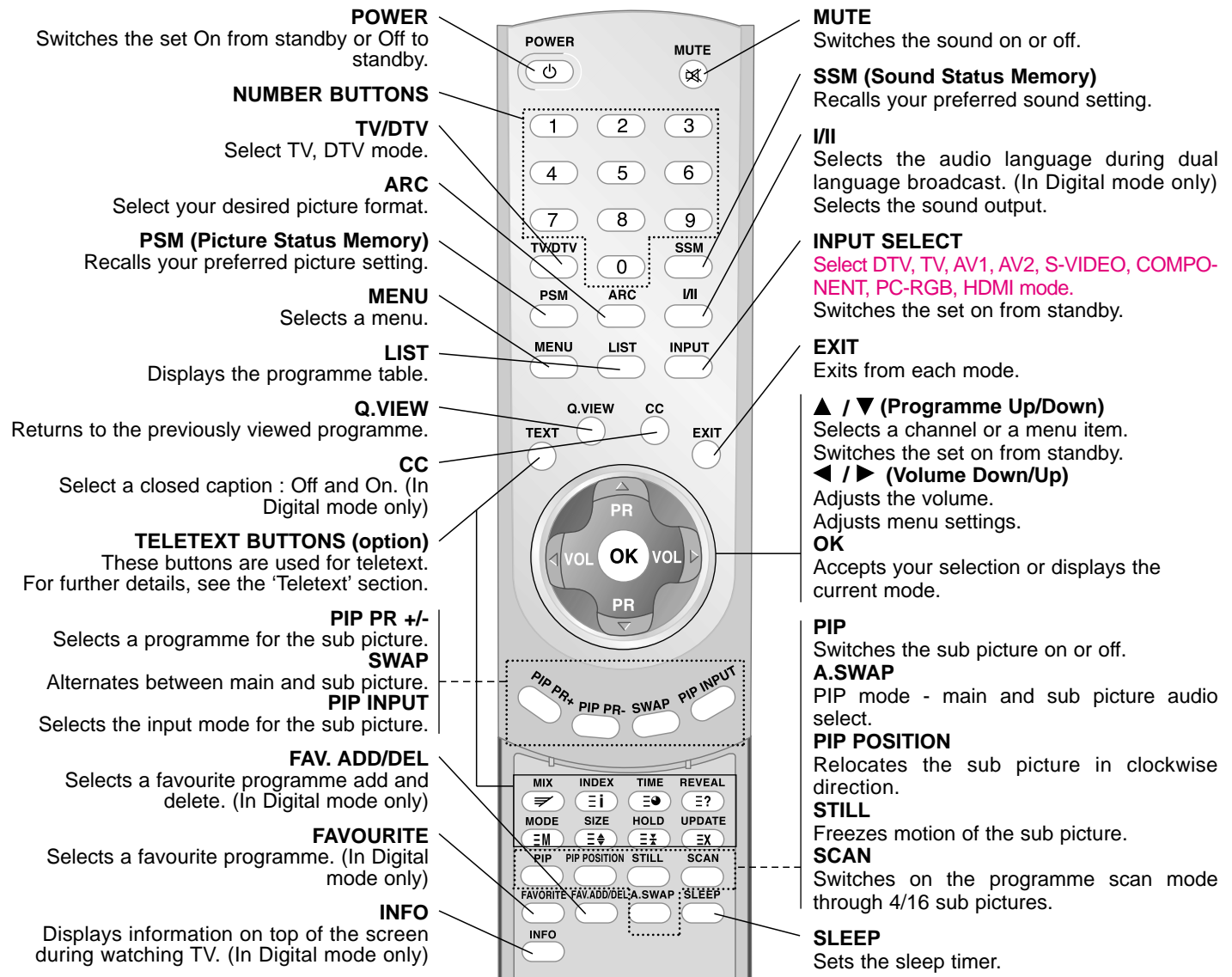

Location and function of controls

Battery installation

- Your remote control handset is powered by two AAA type batteries.

1

To insert batteries, turn the remote control handset over and remove the battery cover.

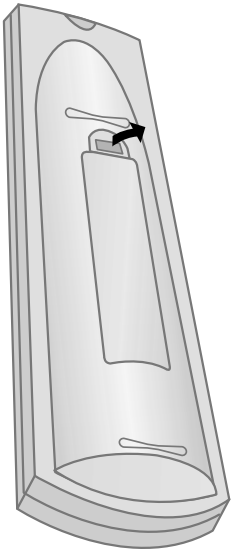

2

Put the two batteries into the compartment observing battery polarity.

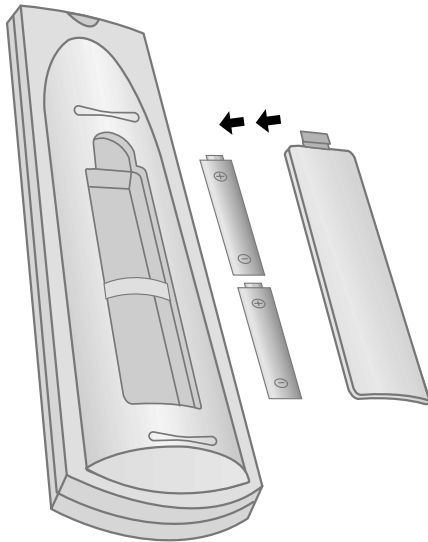

3

Replace the cover.

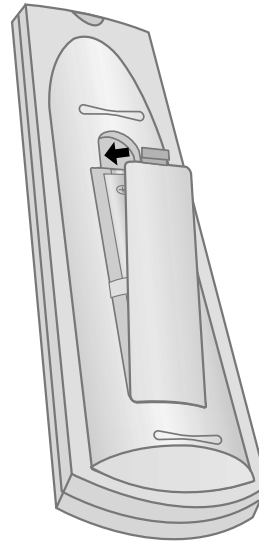

To avoid damage from possible battery leakage, remove the batteries if you do not plan to use the remote control handset for an extended period time. Do not use batteries of differing age or type. Always discard of batteries safely.

Location and function of controls

Front panel

- Shown is a simplified representation of the set.
- Here shown may be somewhat different from your set.

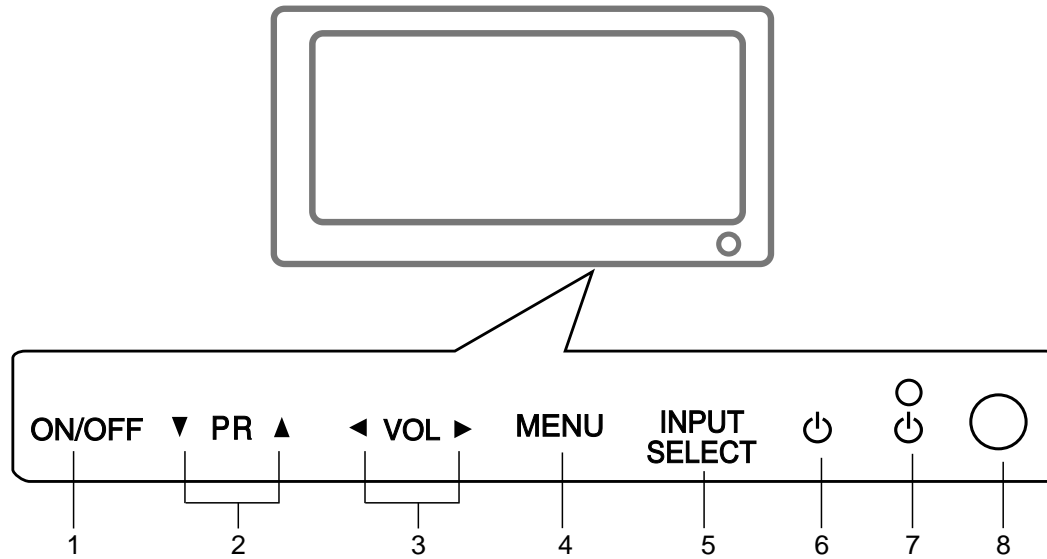

1. MAIN POWER (ON/OFF)
Switches the set On or Off.

2. ▲ / ▼ (Programme Up/Down)
Selects a channel or a menu item.
Switches the set On from standby.

3. ◀ / ▶ (Volume Down/Up)
Adjusts the volume.
Adjusts menu settings.

4. MENU
Selects a menu.

5. INPUT SELECT
Select DTV, TV, AV1, AV2, S-VIDEO, COMPONENT, PC-RGB, HDMI mode.

6. POWER (⏻)
Switches the set On from standby or On to standby.

7. POWER/STANDBY INDICATOR (⦿)
Illuminates red in standby mode.
Illuminates green when the set is switched on.

8. REMOTE CONTROL SENSOR

Location and function of controls

Back panel

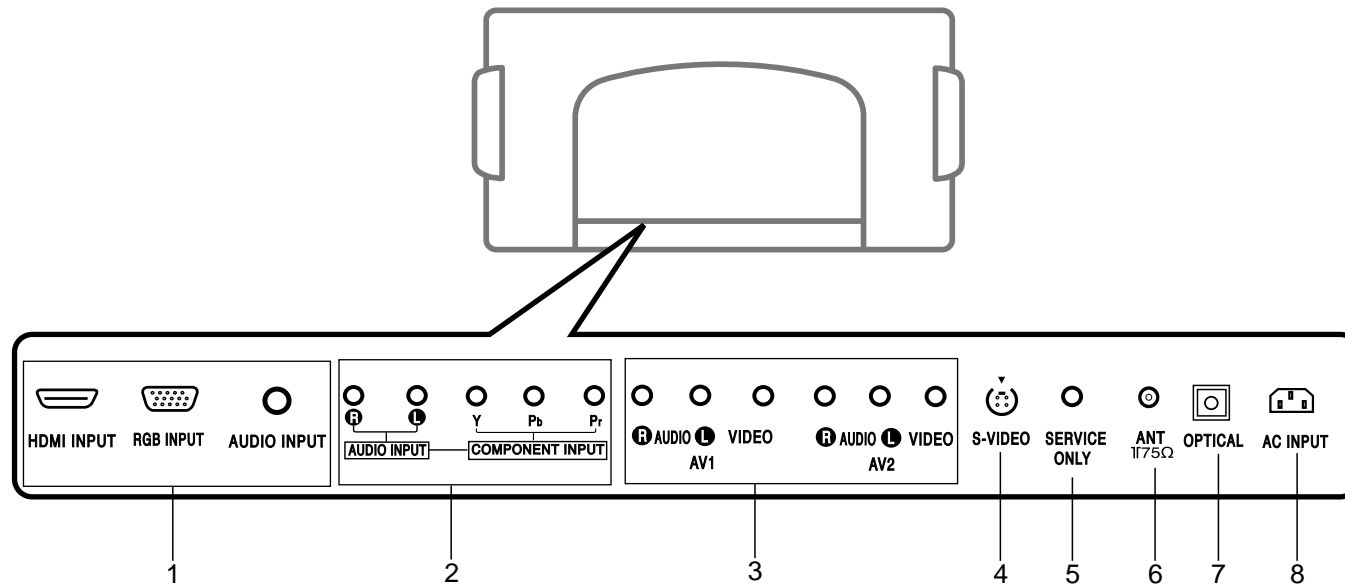

1. **HDMI INPUT / RGB INPUT / AUDIO INPUT SOCKETS**
Connect the set output socket of the PERSONAL COMPUTER to this socket.
2. **AUDIO INPUT / COMPONENT INPUT (480i / 576i / 480p / 576p / 720p / 1080i) SOCKETS**
3. **AUDIO/VIDEO SOCKET**
Connect the audio/video out sockets of the VCR to AV sockets of the set
4. **S-VIDEO INPUT**
Connect video out from an S-VIDEO VCR to the S-VIDEO input.
5. **SERVICE ONLY SOCKET**

6. **Antenna INPUT**
7. **Digital Audio (OPTICAL)**
Connect digital audio from various types of equipment.
Note : *In standby mode, these ports will not work.*
(HDMI & DTV input)
8. **POWER CORD SOCKET**
This set operates on an AC power.
The voltage is indicated on the Specifications page.
Never attempt to operate the set on DC power.

Connection to External equipment

- You can connect additional equipment, such as VCRs, camcorders etc. to your set. However please check with your manufacturers instruction books for specific information. Make sure all connections are made with both your set and additional appliance unplugged from the mains to avoid damaging your equipment. Here shown may be somewhat different from your set.

1 Antenna Connection

- Be careful for the bronze wire not to be bender in connecting to antenna input port.

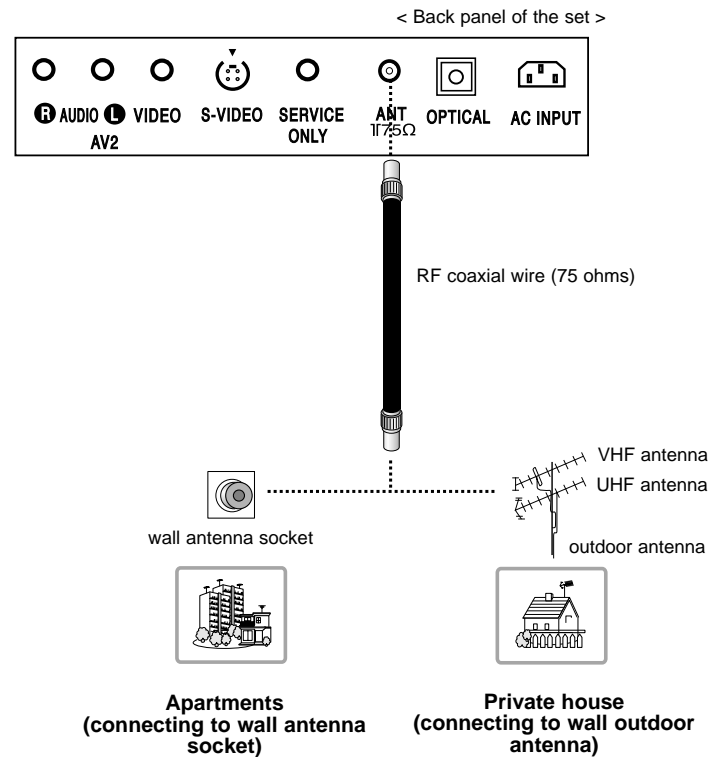

2 Watching VCR

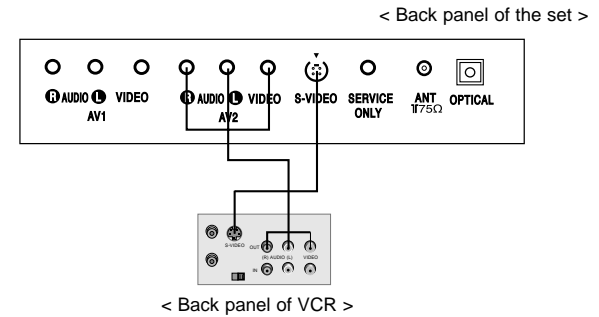

- If you connect an S-VIDEO VCR to the S-VIDEO input, the picture quality is improved; compared to connecting a regular VCR to the Video input.
- To avoid picture noise (interference), leave an adequate distance between the VCR and set.

Use the **INPUT SELECT** button on the remote control to select **AV1** or **AV2**.
(If connected to S-VIDEO, select the **S-Video** external input source.)

Insert a video tape into the VCR and press the **PLAY** button on the VCR. (See VCR owner's manual)

3

Watching Cable TV

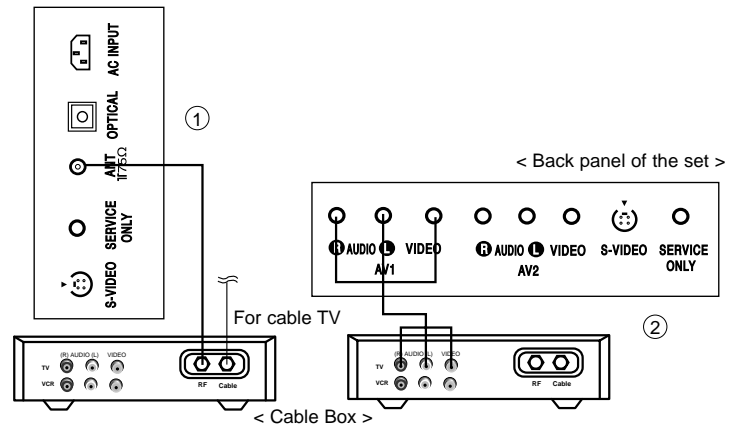

- After subscribing for a local cable TV station and installing a converter you can watch cable TV.
- For further information of cable TV, contact the local cable TV station.

In using connection 1

Select programme number in programme switch of cable box.
Match the set programme with selected programme of cable box.
Select your desired programme with the remote control for cable box.

In using connection 2

Use the **INPUT SELECT** button on the remote control and select **AV1** or **AV2**.

Tune to cable service provided channels using the cable box.

4

Watching external AV source

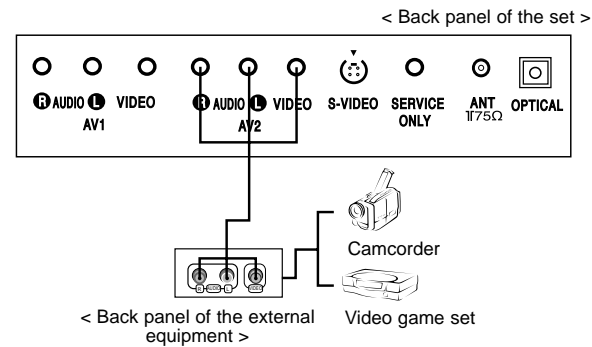

When connecting the set to an external source, match the colours of AUDIO/VIDEO input jacks on the set with the output jacks on the audio/video equipment: Video = yellow, Audio (Left) = white, Audio (Right) = red.

Use the **INPUT SELECT** button on the remote control to select **AV1** or **AV2**.

Operate the corresponding external equipment.
See external equipment operating guide.

Connection to External equipment

5 Watching DVD

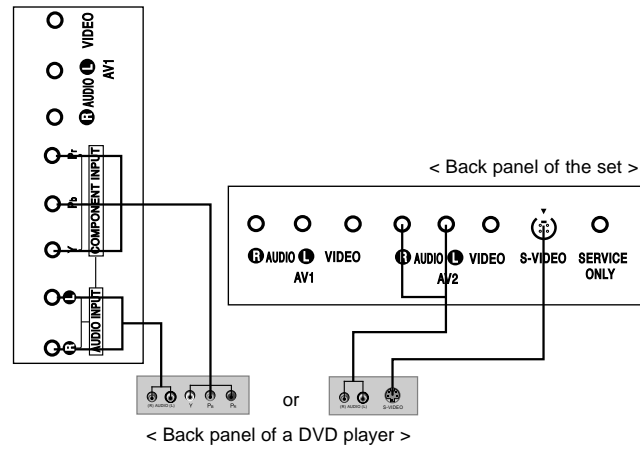

How to connect

Connect DVD video inputs to Y, Pb, Pr of COMPONENT (DVD INPUT) and audio inputs to Audio sockets of AUDIO INPUT.

How to use

Turn on the DVD player, and insert a DVD.

Use **INPUT SELECT** button on the remote control to select **Component**.

Refer to the DVD player's manual for operating instructions.

• Component Input ports

You can get better picture quality if you connect DVD player with component input ports as below.

Component ports of the set	Y	P _B	P _R
Video output ports of DVD player	Y	P _b	P _r
	Y	B-Y	R-Y
	Y	Cb	Cr
	Y	P _B	P _R

6

Connecting HDMI

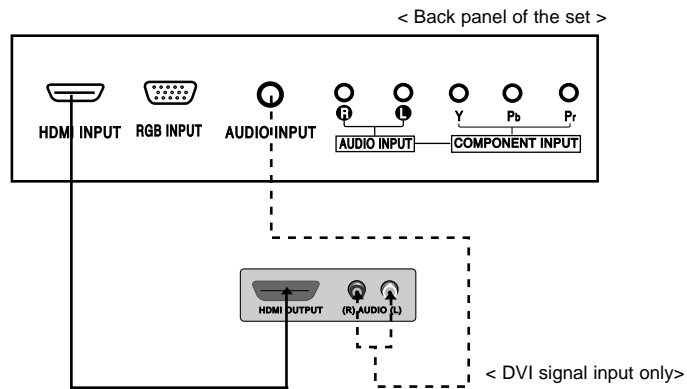

Connect the signal cable from the monitor output socket of the PERSONAL COMPUTER to the **HDMI INPUT** socket of the set.

Connect the audio cable from the PC to the **AUDIO INPUT** sockets of the set.

Press the **INPUT SELECT** button to select **HDMI**.

Switch on the HDMI, and the HDMI screen appears on the set.

HDMI input signal : 480p-60Hz, 576p-50Hz, 720p-50Hz, 720p-60Hz, 1080i-50Hz, 1080i-60Hz.

HDMI Interface with HDCP Copy Protection enables all-digital rendering of video without the losses.

This TV SET can receive the High-Definition Multimedia Interface(HDMI) or Input of Digital Visual Interface(DVI).

7 Connecting PC

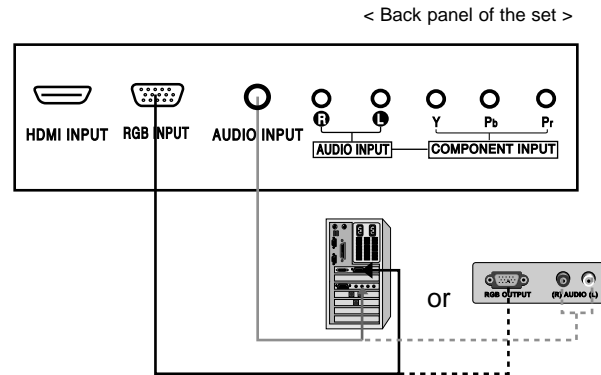

Connect the signal cable from the monitor output socket of the PERSONAL COMPUTER to the **RGB INPUT** socket of the set.

Connect the audio cable from the PC to the **AUDIO INPUT** sockets of the set.

Press the **INPUT SELECT** button to select **PC-RGB**.

Switch on the PC, and the PC screen appears on the set.

The set can be operated as the PC monitor.

RGB input signal : 480p-60Hz, 576p-50Hz, 720p-50Hz, 720p-60Hz, 1080i-50Hz, 1080i-60Hz.

8 Connecting Digital Audio (HDMI & DTV input)

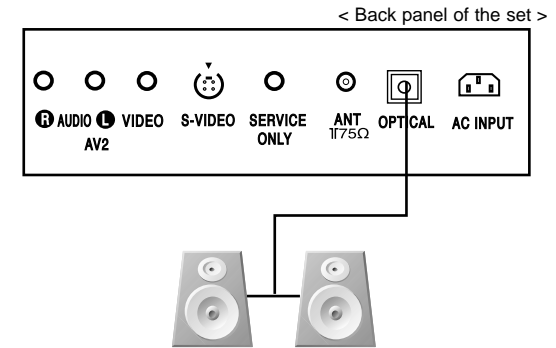

- Send the set's audio to external audio equipment (stereo system) via the Digital Audio Output (Optical)

Caution : Do not look into the optical output port. Looking at the laser beam may damage your vision.

How to connect

Connect one end of an optical cable to the TV Digital Audio (Optical) Output port.

Connect the other end of the optical cable to the digital audio (optical) input on the audio equipment.

Note : Digital Audio Output works, when it's inputted HDMI signal to the set.

1

On and Off

Press the main power button to switch the set on.

If the set is in standby mode, press the **POWER**, **▲ / ▼** buttons on the remote control handset to switch it on fully.

Press the **POWER** button on the remote control handset.

The set reverts to standby mode.

Press the main power button again to switch the set off.

ON : "GREEN" LED
Stand-by : "RED" LED
During stand-by to ON condition, the LED will be flashing in "ORANGE".

2

Programme selection

You can select a programme number with the **▲ / ▼** or **NUMBER** buttons.

3

Volume adjustment

Press the **◀ / ▶** button to adjust the volume.

If you want to switch the sound off, press the **MUTE** button.

You can cancel it by pressing the **MUTE**, **◀ / ▶**, **SSM** or **I/II** button.

4

On screen language selection (option)

Press the **MENU** button and then use **▲ / ▼** button to select the **SETUP** menu.

Press the **▶** button and then use **▲ / ▼** button to select **Language**.

Press the **▶** button and then use **▲ / ▼** button to select your desired language. All the on screen displays will appear in the selected language.

Repeatedly press the **MENU** button to return to normal TV viewing.

On screen menus

Menu selection

- The dialogue between you and your set takes place on screen with an operator menu. The buttons required for the operating steps are also displayed.

1

Press the **MENU** button and then use ▲ / ▼ button to display each menu.

Press the ► button and then use ▲ / ▼ button to select a menu item.

2

Press the ► button to display the sub menu or the pull-down menu.

Change the setting of an item in the sub or pull-down menu with ◀ / ▶ or ▲ / ▼.

You can move to the higher level menu with ◀ button and to move to the lower level menu press the ► button.

Note : Menus may vary according to input mode.

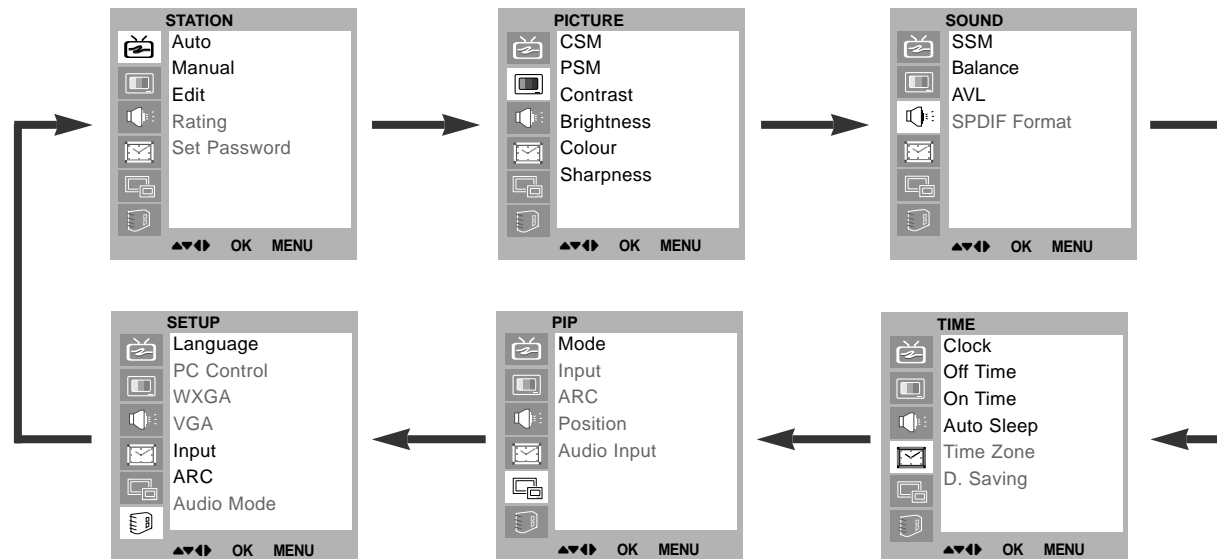

Setting up TV stations

Auto programme tuning

- Stations can be tuned using automatic or manual modes.
- All stations that can be received are stored by this method. It is recommended that you use auto programme during installation of this set.

1

Press the **MENU** button and then use **▲ / ▼** button to select the **STATION** menu.



2

Press the **▶** button and then use **▲ / ▼** button to select **Auto**.

Press the **▶** button to display the **Auto** menu.

Press the **▲ / ▼** button to select **System**.

Press the **◀ / ▶** button to select **ALL, DTV, TV**.

ALL : Digital & Analogue search

DTV : Digital search only

TV : Analogue search only

Press the **▲ / ▼** button to select **Storage From**.

Select the beginning programme number with the **◀ / ▶** button on the **Storage From** pull down menu.

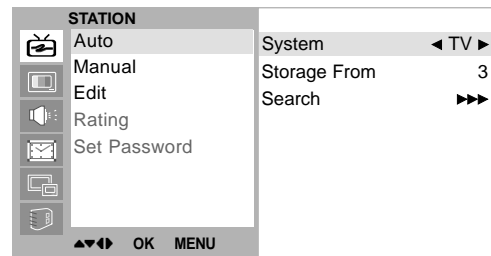

3

Press the **▲ / ▼** button to select **Search**.

Press the **▶** button to begin auto programming. All receivable stations are stored.

To stop auto programming, press the **MENU** button.

When auto programming is completed, the **Edit** menu appears on the screen. See the 'Edit' section to edit the stored programme.

Repeatedly press the **MENU** button to return to normal TV viewing.

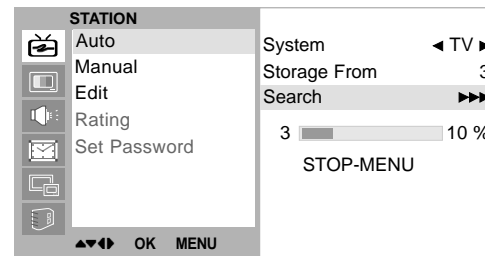

Setting up TV stations

Manual programme tuning

(in analogue mode only)

- Manual programme lets you manually tune and arrange the stations in whatever order you desire. Also you can assign a station name with five characters to each programme number.

1
Press the **MENU** button and then use **▲ / ▼** button to select the **STATION** menu.

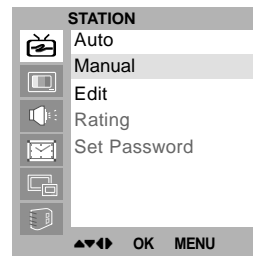

2
Press the **▶** button and then use **▲ / ▼** button to select **Manual**.

Press the **▶** button to display the **Manual** menu.

Press the **▲ / ▼** button to select **Storage**.

Press the **◀ / ▶** button to select the programme number.

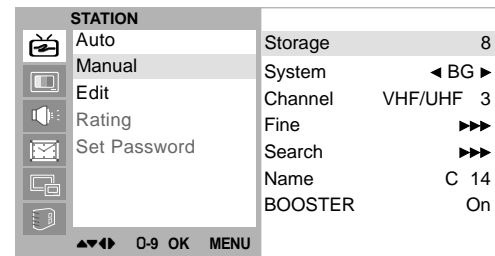

3
Press the **▲ / ▼** button to select **System**.

Select a TV system with the **◀ / ▶** button on the **System** pull-down menu;

M : NTSC M (USA / Korea / Philippines)

BG : PAL B/G, SECAM B/G
(Europe/East Europe/Australia)

I : PAL I (U.K./Ireland)

DK : PAL D/K, SECAM D/K (East Europe)

Press the **▲ / ▼** button to select **Channel**.

Press the **◀ / ▶** button to select **V/UHF** or **CABLE** on the **Channel** pull-down menu.

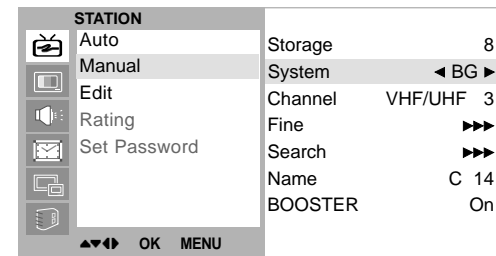

Setting up TV stations

Manual programme tuning (in analogue mode only)

4

Normally fine tuning is only necessary if reception is poor.

Press the ▲ / ▼ button to select **Fine**.

Press the ◀ / ▶ button to fine tune for the best picture and sound.

Press the ▲ / ▼ button to select **Search**.

Press the ◀ / ▶ button to commence searching on the **Search** pull-down menu. If a station is found the search will stop.

If this station is the one required, press the **OK** button to store it.

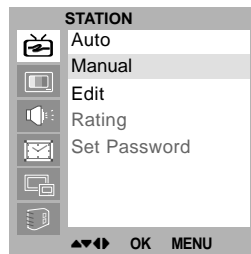

5

Press the ▲ / ▼ button to select **Name**.

Press the ▶ button on the **Name** pull-down menu.

Press the ▲ button. You can use a blank, +, -, the numeric **0** to **9** and the alphabet **A** to **Z**.

With the ▼ button you can select in the opposite direction.

Select the position by pressing the ◀ / ▶ button and then take your choice of the second character, and so on.

Press the **OK** button.

In some models, **BOOSTER** is an optional function.

Only a set with **BOOSTER** can perform this function.

If the reception is poor at the fringe area of TV signal, select **BOOSTER** to **On**.

Press the ▲ / ▼ button to select **BOOSTER**.

Press the ◀ / ▶ button to select **On** or **Off**.

Repeatedly press the **MENU** button to return to normal TV viewing.

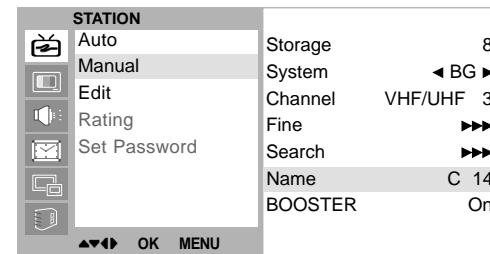
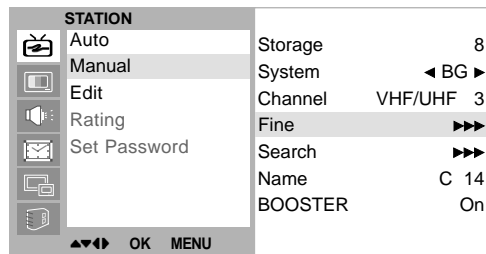

Setting up TV stations

Programme edit

(in analogue mode only)

- This function enables you to delete or skip the stored programmes. Also you can move some stations to other programme numbers or insert a blank station data into the selected programme number.

1
Press the **MENU** button and then use **▲ / ▼** button to select the **STATION** menu.

Press the **▶** button and then use **▲ / ▼** button to select **Edit**.

Press the **▶** button twice to display the **Edit** menu.

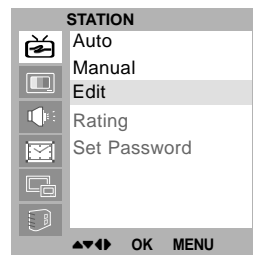

2
Deleting a programme

Select a programme to be deleted with the **▲ / ▼** or **◀ / ▶** button.

Press the **RED** button twice. The selected programme is deleted, all the following programmes are shifted up one position.

3
Copying a programme

Select a programme to be copied with the **▲ / ▼** or **◀ / ▶** button.

Press the **GREEN** button. All the following programmes are shifted down one position.

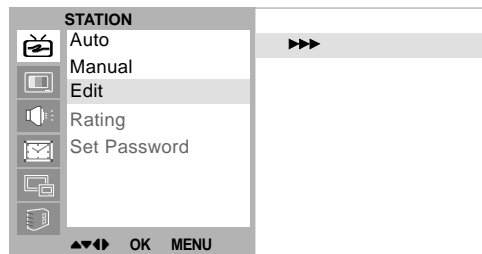

4
Moving a programme

Select a programme to be moved with the **▲ / ▼** or **◀ / ▶** button.

Press the **YELLOW** button.

Move the programme to the desired programme number with the **▲ / ▼** or **◀ / ▶** button.

Press the **YELLOW** button again to release this function.

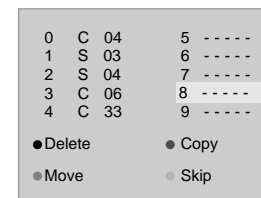

Setting up TV stations

Programme edit

Calling the programme table

(in analogue mode only)

- You can check the programmes stored in the memory by displaying the programme table.

5

Skipping a programme number

Select a programme number to be skipped with the ▲ / ▼ or ◀ / ▶ button.

Press the **BLUE** button.

The skipped programme turns to blue.

Press the **BLUE** button again to release the skipped programme.

When a programme number is skipped it means that you will be unable to select it using the ▲ / ▼ button during normal TV viewing. If you want to select the skipped programme, directly enter the programme number with the **NUMBER** buttons or select it in the programme edit or table menu.

Repeatedly press the **MENU** button to return to normal TV viewing.

1

Displaying programme table

Press the **LIST** button to display the **Programme table** menu. The programme table appears on the screen. One programme table contains ten programmes as below.

You may find some blue programmes. They have been set up to be skipped by auto programming or in the programme edit mode. Some programmes with the channel number shown in the programme table indicate there is no station name assigned.

2

Selecting a programme in the programme table

Select a programme with the ▲ / ▼ or ◀ / ▶ button. Then press the **OK** button. The set switches to the chosen programme number.

3

Paging through a programme table

There are 10 programme table pages which contain 100 programmes. Pressing the ▲ / ▼ or ◀ / ▶ button repeatedly turns the pages.

Repeatedly press the **MENU** button to return to normal TV viewing.

Setting up TV stations DTV Info (in digital mode only)

1

Press the **MENU** button and then use ▲ / ▼ button to select the **STATION** menu.

Press the ► button and then use ▲ / ▼ button to select **DTV Info**.

Press the ► button and then use ▲ / ▼ button to select **Channel list**.

Press the ► button to display the **Channel list** menu.

Repeatedly press the **MENU** button to return to normal DTV viewing.

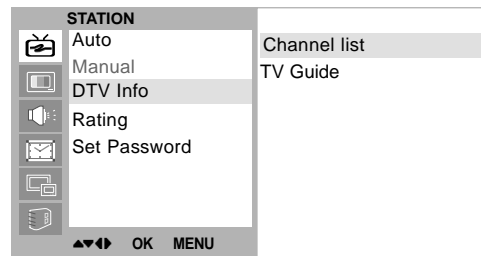
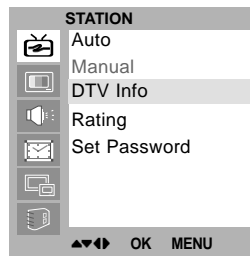

Setting up TV stations

Rating Setup (in digital mode only)

Rating menu options (in digital mode only)

Press the **MENU** button and then use ▲ / ▼ button to select the STATION menu.

Press the ► button and then use ▲ / ▼ button to select **Rating**.

Press the ► button to enter the password as requested.

The TV is set with the initial password "0-0-0-0".

Press the ▲ / ▼ button to select type of ratings to block .

Repeatedly press the **MENU** button to return to normal DTV viewing.

- **No Block**
All programs can be watched because there is no age limitation.
- **R & Above (Restricted 18+)**
Programs are blocked for children under the age of 18.
- **AV & Above (Adult Audience strong violence 15+)**
This program contains the strong violent contents. Therefore, programs are blocked for children under the age of 15
- **MA & Above (Mature Adult Audience 15+)**
Programs are blocked for children under the age of 15.
- **M & Above (Mature Audience 15+)**
Programs are blocked for children under the age of 15.
- **PG & Above (Parental Guidance Recommended)**
This programs contains unsuitable materials that parents want to prevent their children from watching.
- **G & Above (General Audience)**
This programs is designed to be appropriate for all ages.
- **Block All**
All programs are blocked without considering the age level.

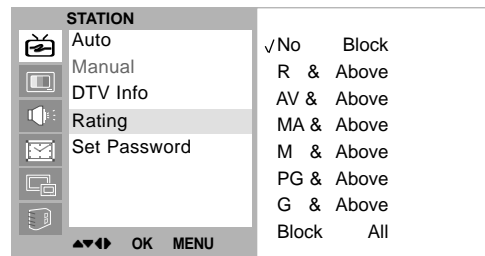
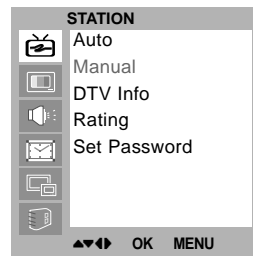

Setting up TV stations

Set password (in digital mode only)

Press the **MENU** button and then use ▲ / ▼ button to select the STATION menu.

Press the ► button and then use ▲ / ▼ button to select **Set password**.

Press the ► button to enter the password as requested.

The TV is set with the initial password "0-0-0-0".

Press the ► button and then enter a four digit password.

Enter it again when requested.

Repeatedly press the **MENU** button to return to normal DTV viewing.

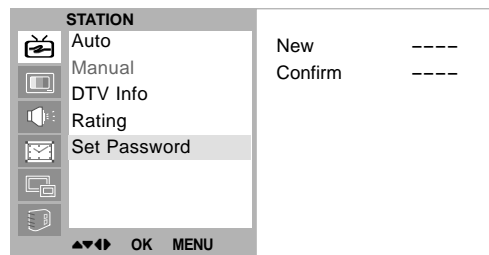

Picture Menu

1

CSM (Colour Status Memory)

To initialize values (reset to default settings), select the **Normal** option.

Press the **MENU** button and then **▲ / ▼** button to select the PICTURE menu.

Press the **▶** button and then **▲ / ▼** button to select **CSM**.

Press the **▶** button and then **▲ / ▼** button to select the desired colour temperature.

Repeatedly press the **MENU** button to return to normal TV viewing.

You can adjust red, green, or blue to any colour temperature you prefer.

Press the **MENU** button and then use **▲ / ▼** button to select the PICTURE menu.

Press the **▶** button and then use **▲ / ▼** button to select **CSM**.

Press the **▶** button and then use **▲ / ▼** button to select **User**.

Press the **▶** button and then use **▲ / ▼** button to make appropriate adjustments.

Repeatedly press the **MENU** button to return to normal TV viewing.

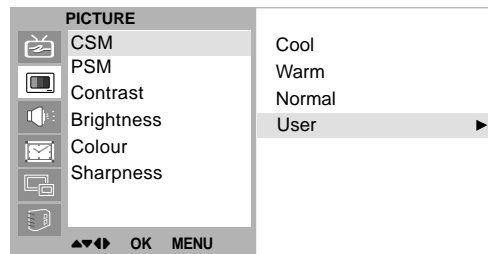

Picture Menu

2

PSM (Picture Status Memory)

Press the **MENU** button and then use ▲ / ▼ button to select the PICTURE menu.

Press the ► button and then use ▲ / ▼ button to select **PSM**.

Press the ► button and then use ▲ / ▼ button to select a picture setting on the **PSM** pull-down menu.

Repeatedly press the **MENU** button to return to normal TV viewing.

You can also recall a desired picture (**Dynamic, Standard, Mild, Game** or **User**) with **PSM** button on the remote control. The picture **Dynamic, Standard, Mild, Game** are programmed for good picture reproduction at the factory and cannot be changed.

3

Manual Picture Control

Press the **MENU** button and then use ▲ / ▼ button to select the PICTURE menu.

Press the ► button and then use ▲ / ▼ button to select the desired picture option.

Press the ► button and then use ◀ / ▶ button to make appropriate adjustments.

You can adjust picture contrast, brightness, colour, sharpness and tint (NTSC input only) to the levels you prefer.

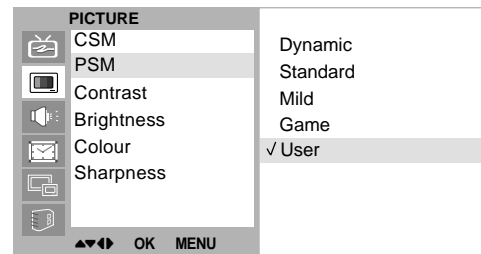

4

Picture format

You can watch TV in various picture formats; 16:9, 14:9, 4:3, ZOOM, PANORAMA, AUTO.
Repeatedly press the **ARC** button to select your desired picture format.

1. Press the **ARC** button to select a desired picture format.

- 16:9, 14:9, ZOOM, PANORAMA, AUTO are available at TV, AV1, AV2, S-VIDEO, COMPONENT(480i/576i) input.
- 16:9, H.ZOOM, V.ZOOM, HV.ZOOM are available at DTV input.
- 16:9, 4:3 are available at COMPONENT(480p, 576p/720p, 1080i), PC-RGB, HDMI input.

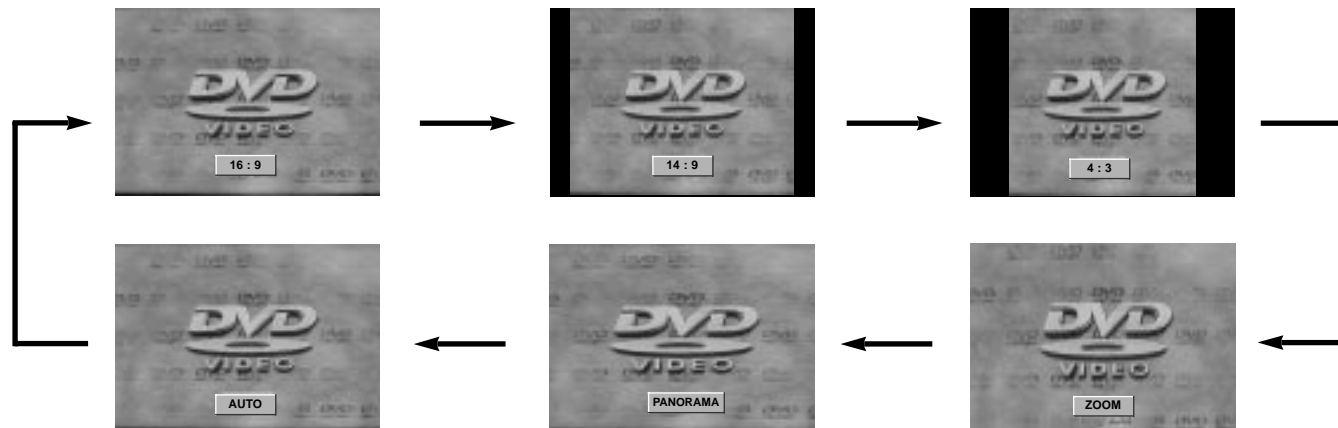

Sound Menu

1

SSM (Sound Status Memory)

Press the **MENU** button and then use **▲ / ▼** button to select the SOUND menu.

Press the **▶** button and then use **▲ / ▼** button to select **SSM**.

Press the **▶** button and then use **▲ / ▼** button to select a sound setting on the **SSM** pull-down menu.

Repeatedly press the **MENU** button to return to normal TV viewing.

Sound Frequency Adjustment

- Press the **▶** button in **User**.
- Select a sound band by pressing the **◀ / ▶** button.
- Make appropriate sound level with the **▲ / ▼** button.
- Press the **OK** button to store it for the sound **User**.

You can also recall a desired sound (**Flat**, **Music**, **Movie**, **Speech** or **User**) with **SSM** button on the remote control. The sound **Flat**, **Music**, **Movie** and **Speech** are programmed for good sound reproduction at the factory and cannot be changed.

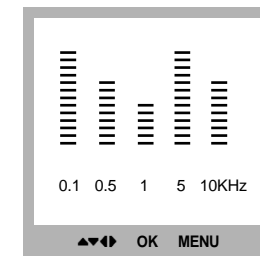
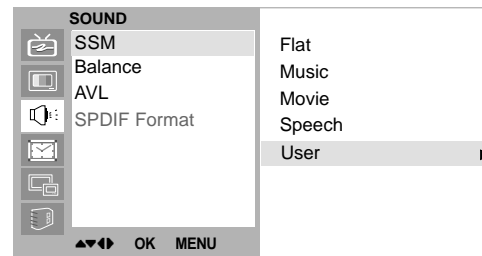
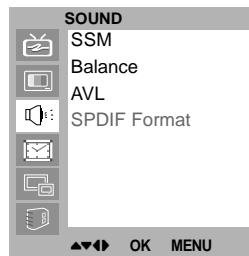

2

Balance

Press the **MENU** button and then use ▲ / ▼ button to select the SOUND menu.

Press the ► button and then use ▲ / ▼ button to select the desired sound item.

Press the ► button and then use ◀ / ▶ button to make appropriate adjustments.

Repeatedly press the **MENU** button to return to normal TV viewing.

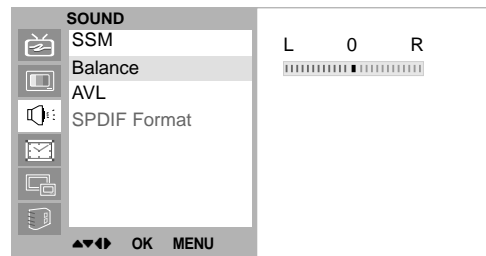
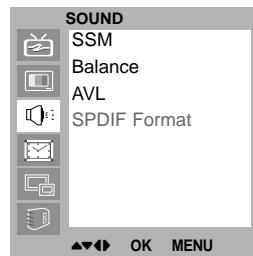

3

AVL (Auto Volume Leveler)

Press the **MENU** button and then use ▲ / ▼ button to select the SOUND menu.

Press the ► button and then use ▲ / ▼ button to select **AVL**.

Press the ► button and then use ▲ / ▼ button to select **On** or **Off**.

Repeatedly press the **MENU** button to return to normal TV viewing.

This feature maintains an equal volume level; even if you change channels.

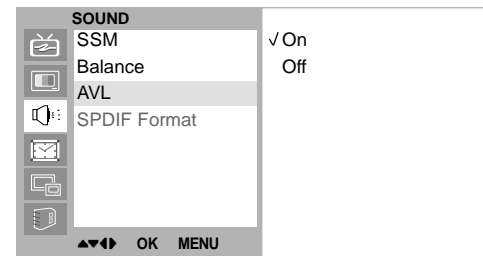

Sound Menu

4

SPDIF Format (in digital mode only)

Press the **MENU** button and then use **▲ / ▼** button to select the **SOUND** menu.

Press the **▶** button and then use **▲ / ▼** button to select **SPDIF Format**.

Press the **▶** button and then use **▲ / ▼** button to select **AC-3** or **PCM**.

Repeatedly press the **MENU** button to return to normal DTV viewing.

Note :

*a : It's available to use **AC-3** or **PCM** in Dolby Digital Audio signal.*

*b : When it doesn't apply the Dolby Digital Audio signal, select the **PCM** function to output the dolby digital audio by SPDIF output.*

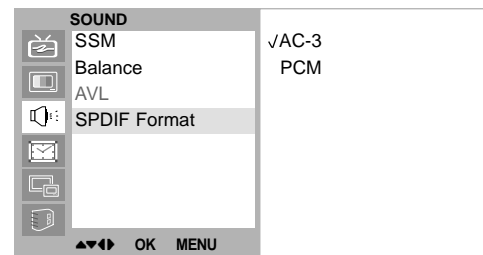
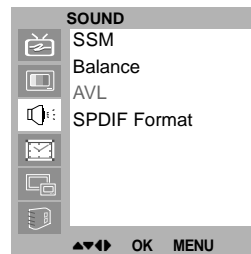

4

Stereo/Dual/NICAM reception

In AV mode, you can select output sound for the left and right loudspeakers. Repeatedly press the **I/II** button to select the sound output.

L+R : Audio signal from audio L input is sent to left loud-speaker and audio signal from audio R input is sent to right loudspeaker.

L+L : Audio signal from audio L input is sent to left and right loudspeakers.

R+R : Audio signal from audio R input is sent to left and right loud-speakers.

Mono sound selection

In stereo reception if the stereo signal is weak, you can switch to mono by pressing the **I/II** button twice. In mono reception the depth of sound is improved. To switch back to stereo, press the **I/II** button twice again.

Language selection for dual language broadcast

If a programme received in two languages (dual language), you can switch to **DUAL I**, **DUAL II** or **DUAL I+II** by pressing the **I/II** button repeatedly.

DUAL I sends the primary broadcast language to the loudspeakers.

DUAL II sends the secondary broadcast language to the loudspeakers.

DUAL I+II sends a separate language to each loudspeaker.

If your set is equipped with the receiver for NICAM reception, the high quality NICAM (Near Instantaneous Companding Audio Multiplex) digital sound can be received.

Sound output can be selected according to the type of received broadcast as follows by pressing the **I/II** button repeatedly.

When NICAM mono is received, you can select **NICAM MONO** or FM MONO.

When NICAM stereo is received, you can select **NICAM STEREO** or FM MONO. If the stereo signal is weak, switch to FM mono.

When NICAM dual is received, you can select **NICAM DUAL I**, **NICAM DUAL II** or **NICAM DUAL I+II** or **MONO**. When FM mono is selected the display **MONO** appears on the screen.

Time Menu

1

Clock

[Auto]

- The time is set automatically from a digital channel signal.
- The digital channel signal includes information for the current time provided by the broadcasting station.
- Set the clock manually, if the current time is set incorrectly by the auto clock function.

Press the **MENU** button and then ▲ / ▼ button to select the TIME menu.

Press the ► button and then ▲ / ▼ button to select **Clock**.

Press the ► button and then ▲ / ▼ button to select **Auto**.

Repeatedly press the **MENU** button to return to normal TV viewing.

[Manual]

- If current time setting is wrong, reset the clock manually.

Press the **MENU** button and then ▲ / ▼ button to select the TIME menu.

Press the ► button and then ▲ / ▼ button to select **Clock**.

Press the ► button and then ▲ / ▼ button to select **Manual**.

Press the ► button and then ▲ / ▼ button to adjust the hour.

Press the ► button and then ▲ / ▼ button to adjust the minute.

Repeatedly press the **MENU** button to return to normal TV viewing.

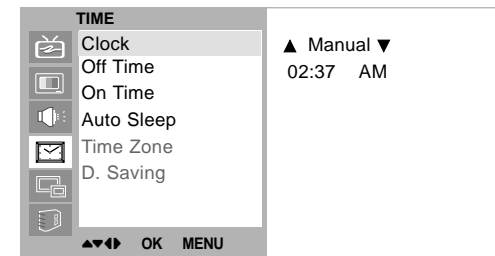
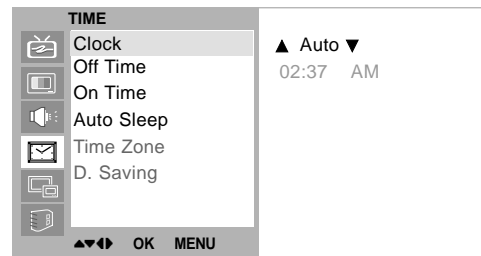
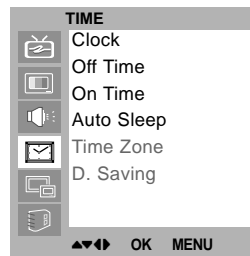

2

On/Off Time

The off timer automatically switches the set to standby at the preset time.

Press the **MENU** button and then **▲ / ▼** button to select the TIME menu.

Press the **▶** button and then **▲ / ▼** button to select **Off Time** or **On Time**.

Press the **▶** button and then **▲ / ▼** button to select **On**.

To cancel **Off/On Time** function, press the **▲ / ▼** button to select **Off**.

Press the **▶** button and then **▲ / ▼** button to adjust the hour.

Press the **▶** button and then **▲ / ▼** button to adjust the minute.

Only On time function; Press the **▶** button and then **▲ / ▼** button to adjust volume level and programme number.

Repeatedly press the **MENU** button to return to normal TV viewing.

Note :

- a. In the event of power interruption (disconnection or power failure), the clock must be reset.
- b. Two hours after the set is switched on by the on time function it will automatically switch back to standby mode unless a button has been pressed.
- c. Once the on or off time is set, these functions operate daily at the preset time.
- d. Off Timer function overrides On Timer function if they are set to the same time.
- e. The set must be in standby mode for the On Timer to work.

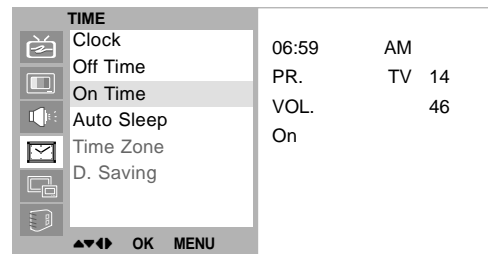
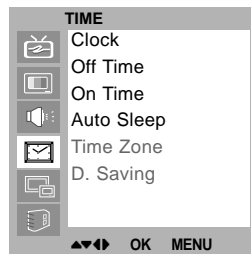

Time Menu

3

Auto sleep

If you select **On** on the **Auto Sleep** menu, the set will automatically switch itself to standby mode approximately ten minutes after a TV station stops broadcasting.

Press the **MENU** button and then **▲ / ▼** button to select the **TIME** menu.

Press the **▶** button and then **▲ / ▼** button to select **Auto Sleep**.

Press the **▶** button and then **▲ / ▼** button to select **On** or **Off**.

Repeatedly press the **MENU** button to return to normal TV viewing.

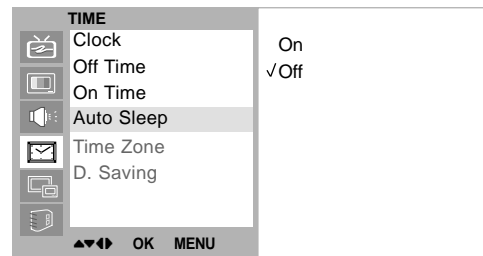
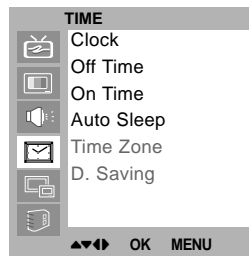

4

Time Zone (in digital mode only)

It's not available to use this function in **Clock Manual** mode.

Press the **MENU** button and then **▲ / ▼** button to select the **TIME** menu.

Press the **▶** button and then **▲ / ▼** button to select **Time Zone**.

Press the **▶** button and then **▲ / ▼** button to select your viewing area time zone : **NSW/ACT, VIC/TAS, QLD, SA, WA, NT, Auto Time Zone**.

Repeatedly press the **MENU** button to return to normal DTV viewing.

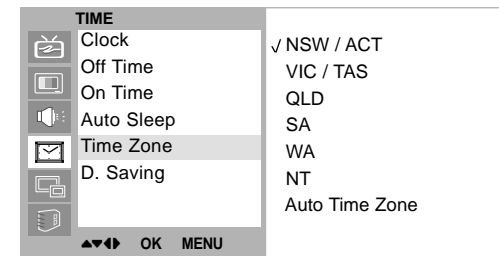

5

Daylight Saving (in digital mode only)

It's not available to use this function in **Clock Manual**, **Auto Time Zone** mode.

Press the **MENU** button and then ▲ / ▼ button to select the TIME menu.

Press the ► button and then ▲ / ▼ button to select **D. Saving**.

Press the ► button and then ▲ / ▼ button to select **On** or **Off**.

Repeatedly press the **MENU** button to return to normal DTV viewing.

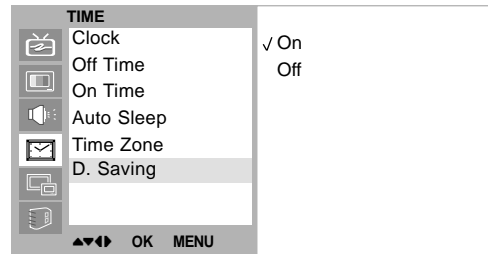

6

Sleep timer

You don't have to remember to switch the set off before you go to sleep. The sleep timer automatically switches the set to standby after the preset time has elapsed.

Press the **SLEEP** button to select the number of minutes. The display '--- min' will appear on the screen, followed by **10, 20, 30, 60, 90, 120, 180** and **240**. The timer begins to count down from the number of minutes selected.

Note :

- To view the remaining sleep time, press the **SLEEP** button once.
- To cancel the sleep time, repeatedly press the **SLEEP** button until the display '--- min' appears.
- When you switch the set off, the set releases the preset sleep time.

Setup Menu

1

Audio Mode (in digital mode only)

This function lets you select your preferred language for audio.

Press the **MENU** button and then **▲ / ▼** button to select the Setup menu.

Press the **▶** button and then **▲ / ▼** button to select **Audio Mode**.

Press the **▶** button and then **▲ / ▼** button to select **Main** or **Sub**.

Repeatedly press the **MENU** button to return to normal DTV viewing.

Note : Depending on the broadcast the main or sub selection may not be available.

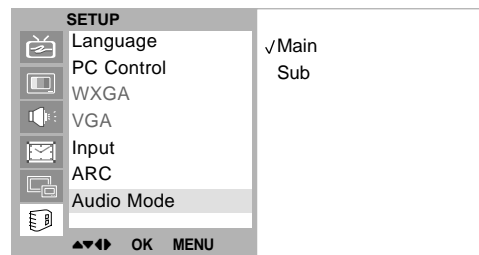

Information / TV Guide (In Digital mode only)

Information (In Digital mode only)

- This function shown the present screen information.

Press the **INFO** button during watching TV.

The service information appears on screen.

Press the **INFO** or **MENU** button to exit.



TV Guide (In Digital mode only)

- This function shown the interactive programme guide.

Press the **INFO** button to twice.

The **TV Guide** appears on screen.

Press the **INFO** or **MENU** button to exit.



Favourite / FAV. Add/Del (in digital mode only)

Favourite (In Digital mode only)

- This function lets you select your favourite programmes directly.

Press the **FAVOURITE** button during watching TV.

The display ' **Favourite on** ' will appear on the screen.

To cancel the favourite, repeatedly press the **FAVOURITE** button until the display ' **Favourite off** ' appears.

< Favourite on mode >

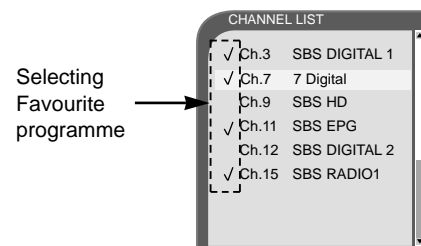
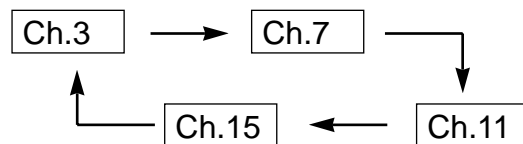

FAV. ADD/DEL (In Digital mode only)

- This function lets you select your favourite programmes add and delete directly

Press the **LIST** button to display the **Channel list** menu.

Select a programme to be add/delete with the **▲ / ▼** button.

Press the **FAV. ADD/DEL** button.

The check mark will appear on the screen.

PC Setup

You can adjust horizontal/vertical position, clock, phase, and auto-configure, reset as you prefer.

Press the **MENU** button and then **▲ / ▼** button to select the SETUP menu.

Press the **▶** button and then **▲ / ▼** button to select the desired picture item.

Press the **◀ / ▶** button to make appropriate adjustments.

H-Position / V-Position

This function is to adjust picture to left/right and up/down as you prefer.

Clock

This function is to minimize any vertical bars or stripes visible on the screen background. And the horizontal screen size will also change.

Phase

WXGA or VGA (Only RGB/HDMI mode)

- When the set is inputted DVI-480p signal in VGA mode, select 480p on the SETUP menu.
- When the set is inputted WXGA signal, select the desired WXGA resolution.

This function allows you to remove any horizontal noise and clear or sharpen the image of characters.

Auto-configure

This function is for the automatic adjustment of the screen position, clock and phase.

The displayed image will disappear for a few seconds while the Auto-configuration is in progress.

Reset

This function allows you to return to the good picture reproduction programmed at the factory and cannot be changed.

Note : Some signal from some graphics boards may not function properly. If the results are unsatisfactory, adjust your monitor's position, clock and phase manually.

Press the **OK** button to store it for the PC monitor picture. Press the **EXIT** button to return to PC mode.

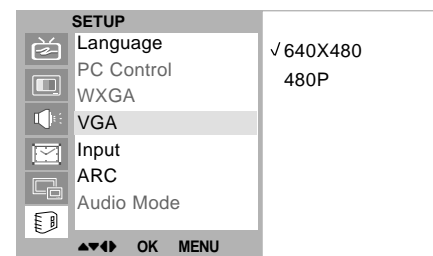
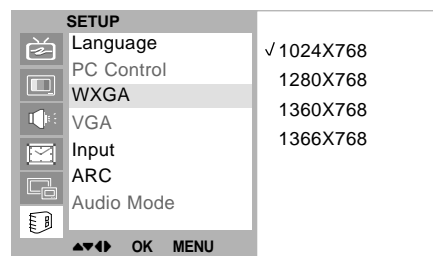
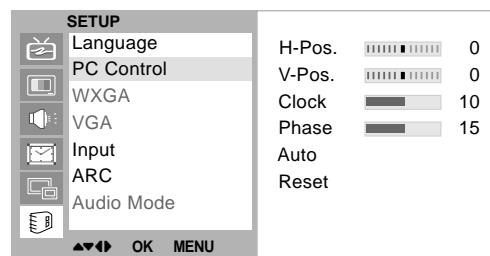

PIP (Picture-In-Picture) Feature

- PIP lets you view 2 different inputs (sources) on your monitor screen at the same time. One source will be large, and the other source will show a smaller inset image.

Watching PIP

Press the **PIP** button to show the sub picture.

- Each press of **PIP** button changes the screen display as shown below.
- The **PIP** function does not work with DTV.
- It's not available to use 1080i in **COMPONENT, PC-RGB, HDMI** mode.

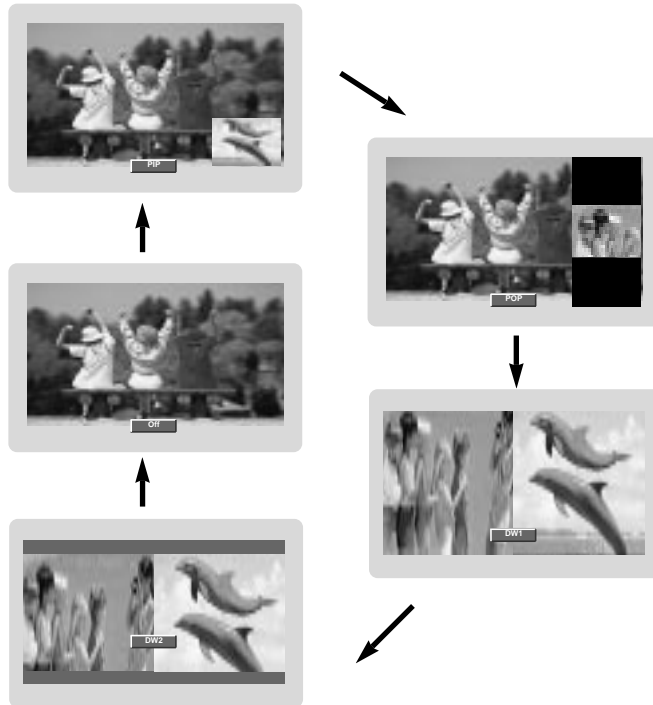

PIP Audio Input

PIP mode - main and sub picture audio select.

Press the **MENU** button and then **▲ / ▼** button to select the PIP menu.

Press the **▶** button and then **▲ / ▼** button to select **Audio Input**.

Press the **▶** button and then **▲ / ▼** button to select **Main** or **Sub**.

Repeatedly press the **MENU** button to return to normal TV viewing.

Note : When main picture and sub picture are selected at the same input, the sub picture selection input will be changed.

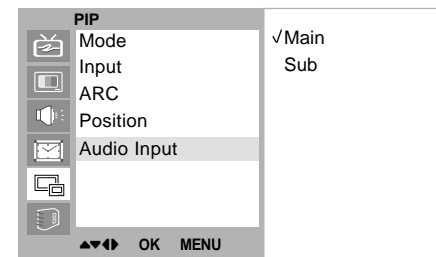

Moving the PIP

Press the **PIP POSITION** button.

Press the **PIP POSITION** button repeatedly until desired position is achieved. The sub pictures move clockwise.



Swapping the PIP

Press the **SWAP** button to exchange the main and sub pictures.

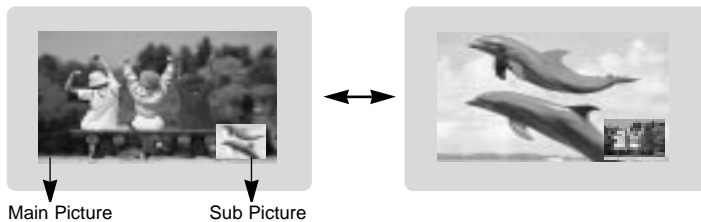

Programme selection for sub picture

Press the **PIP PR +/-** button. The selected programme number is displayed just below the programme number of main picture.

Selecting a Input Signal Source for the PIP

Use the **PIP INPUT** button to select the input source for the sub picture.



Programme scan

This function enables you to search all the stored stations on 4 or 16 sub pictures and see your favorite station by exchanging the main and sub pictures.

When main picture is TV, pressing **SCAN** will give POP 16. When main picture is other inputs, pressing **SCAN** will give POP4.

The selected sub or main pictures search all the stored stations.

Press the **EXIT** button to switch off sub or main pictures.

This function works in the following sub picture mode : TV, AV1, AV2, S-VIDEO.



Teletext (option)

Teletext (or TOP text) is an optional function, therefore only a set with the teletext system can receive the teletext broadcast.

Teletext is a free service broadcast by most TV stations which gives up-to-the-minute information on news, weather, television programmes, share prices and many other topics.

The teletext decoder of this TV can support the SIMPLE, TOP and FASTEXT systems. SIMPLE (standard teletext) consists of a number of pages which are selected by directly entering the corresponding page number. TOP and FASTEXT are more modern methods allowing quick and easy selection of teletext information.

Switch on/off

Press the **TEXT** button to switch to teletext.

The initial page or last page appears on the screen.

Two page numbers, TV station name, date and time are displayed on the screen headline. The first page number indicates your selection, while the second shows the current page displayed.

Press the **TEXT** button to switch off teletext. The previous mode reappears.

SIMPLE text

Page selection

1. Enter the desired page number as a three digit number with the **NUMBER** buttons. If during selection you press a wrong number, you must complete the three digit number and then re-enter the correct page number.
2. The **▲ / ▼** button can be used to select the preceding or following page.

Programming a colour button in LIST mode

If the TV is in SIMPLE text, TOP text or FASTEXT mode,  press the button to switch to LIST mode.

Four teletext page numbers of your choice can be colour coded and easily selected by pressing the corresponding coloured button on the remote control handset.

1. Press a coloured button.
2. Using the **NUMBER** buttons, select the page you wish to programme.
3. Press the **OK** button. The selected page is stored as the selected page number, blinking once to confirm this. From now on, you can select this page with the same coloured button.
4. The three other coloured buttons are programmed in this way.

TOP text (option)

The user guide displays four fields-red, green, yellow and blue at the bottom of the screen. The yellow field denotes the next group and the blue field indicates the next block.

Block / group / page selection

1. With the blue button you can progress from block to block.
2. Use the yellow button to proceed to the next group with automatic overflow to the next block.
3. With the green button you can proceed to the next existing page with automatic overflow to the next group.
Alternatively the **▲** button can be used.
4. The red button permits to return to previous selection.
Alternatively the **▼** button can be used.



Direct page selection

Corresponding to the SIMPLE teletext mode, you can select a page by entering it as a three digit number using the **NUMBER** buttons in TOP mode.

FASTEXT

The teletext pages are colour coded along the bottom of the screen and are selected by pressing the corresponding coloured button.

Page selection

1. Press the  button to select the index page.
2. You can select the pages which are colour coded along the bottom line with the same coloured buttons.
3. Corresponding to the SIMPLE teletext mode, you can select a page by entering its three digit page number with the NUMBER buttons in FASTEXT mode.
4. The  button can be used to select the preceding or following page.

Special teletext functions

REVEAL

Press this button to display concealed information, such as solutions of riddles or puzzles.

Press this button again to remove the information from the display.

SIZE



Selects double height text.

Press this button to enlarge the top half of the page.

Press this button again to enlarge the bottom half of the page.

Press this button again to return to the normal display.

UPDATE

Displays the TV picture on the screen while waiting for the new teletext page. The display  will appear at the top left hand corner of the screen. When the updated page is available then display  will change to the page num-

ber.

Press this button to view the updated teletext page.

HOLD

Stops the automatic page change which will occur if a teletext page consists of 2 or more sub pages. The number of sub pages and the sub page displayed is, usually, shown on the screen below the time. When this button is pressed the stop symbol is displayed at the top left-hand corner of the screen and the automatic page change is inhibited.

To continue press this button again.

MIX

Displays the teletext pages superimposed on the TV picture.

To switch the TV picture off press this button again.

TIME

When viewing a TV programme, press this button to display the time at the top right hand corner of the screen. Press this button again to remove the display. In the teletext mode, press this button to select a sub page number. The sub page number is displayed at the bottom of the screen. To hold or change the sub page, press the RED / GREEN,  or NUMBER buttons.

Press this button again to exit this function.

Displayable Monitor Specification

RGB Mode / DVI Mode

MODE	Resolution	Horizontal Frequency (KHz)	Vertical Frequency (Hz)
DOS	640X350	31.5	70.0
	720X400	31.5	70.0
VGA	640X480	37.9	85.0
		31.5	60.0
		37.8	72.0
		37.5	75.0
SVGA	800X600	43.2	85.0
		35.1	56.0
		37.9	60.0
		48.0	72.0
		46.9	75.0
XGA	1024X768	53.7	85.0
		48.4	60.0
		56.4	70.0
		60.0	75.0
SXGA	1280X1024	60.0	85.0
		63.9	60.0
		75.0	70.0
		79.9	75.0
WXGA	1280X768	91.1	85.0
		47.7	60.0
		60.1	75.0
UXGA	1360X768	68.5	85.0
	1366X768	49.0	60.0
UXGA	1600X1200	49.0	60.0
MAC	832X624	75.0	60.0
		49.7	75.0

(Synchronization input form : separate)

Note:

- If the set is cold, there may be a small "flicker" when the set is switched on. This is normal, there is nothing wrong with the set.
- If possible, use the VESA 1,024x768@60Hz video mode to obtain the best image quality for your LCD monitor. If used to PC vertical frequency 85Hz, some noise can be seen when PIP is on.
In this case, set the PC vertical frequency to 60Hz. The set has been pre-adjusted to the mode VESA 1,024x768@60Hz.
- Some dot defects may appear on the screen, like Red, Green or Blue spots. However, this will have no impact or effect on the monitor performance.
- Do not press the LCD screen with your finger for a long time as this may produce some temporary distortion effects on the screen.
- When the PC screen appears on the set, a message may appear on the screen, and the message will differ according to the Window system version (Win98, 2000). If a message appears click "Next" until the message finishes.
- If the message "**Out Of Range**" appears on the screen, adjust the PC as in the 'Displayable Monitor Specification' section.

Product Spec.

Model	NLT-26HD1	
Main body (With stand)	Horizontal size 818.8 mm Height 457(508.6) mm	Thickness 102.3(138.5) mm
Television system	PAL-BG, I, DK / SECAM-BG, DK / NTSC-M	
Television programme	VHF : 0 ~ 11 UHF : 28 ~ 69 Cable : S1 ~ S41	
LCD Panel	26" wide TFT LCD panel	
Resolution	WXGA (1366 X 768)	
Power consumption	140W	
Stand by Power consumption	Below 3W	
External antenna impedance	75 Ω	
Audio output	15W + 15W	
External IN/OUT ports	<ul style="list-style-type: none"> • HDMI IN 1 • S-VIDEO IN 1 • COMPONENT IN 1 • SERVICE IN 1 • SPDIF OUT 1 • PC IN 1 • AV IN 2 • ANTENNA IN 1 • PC AUDIO IN 1 	
AC Power	100-240v~ , 2.5A-1.5A, 50/60Hz	
Net Weight	18Kg	
Gross Weight	20Kg	

Note.

- a. Although LCD panel uses highly precise technology, it may display blank pixels, dark spots, or lightning on the screen. This is normal and not an indication of a defect.
- b. Technical specification are subject to change without notice.

Product Spec.

Model	NLT-32HD1	
Main body (With stand)	Horizontal size 950 mm Height 515(569.9) mm	Thickness 104(169) mm
Television system	PAL-BG, I, DK / SECAM-BG, DK / NTSC-M	
Television programme	VHF : 0 ~ 11 UHF : 28 ~ 69 Cable : S1 ~ S41	
LCD Panel	32" wide TFT LCD panel	
Resolution	WXGA (1366 X 768)	
Power consumption	160W	
Stand by Power consumption	Below 3W	
External antenna impedance	75 Ω	
Audio output	15W + 15W	
External IN/OUT ports	<ul style="list-style-type: none"> • HDMI IN 1 • S-VIDEO IN 1 • COMPONENT IN 1 • SERVICE IN 1 • SPDIF OUT 1 • PC IN 1 • AV IN 2 • ANTENNA IN 1 • PC AUDIO IN 1 	
AC Power	100-240v~ , 2.5A-1.5A, 50/60Hz	
Net Weight	19Kg	
Gross Weight	23Kg	

Product Spec.

Model	NLT-37HD1	
Main body (With stand)	Horizontal size 1094 mm Height 604(662.5) mm	Thickness 130(235) mm
Television system	PAL-BG, I, DK / SECAM-BG, DK / NTSC-M	
Television programme	VHF : 0 ~ 11 UHF : 28 ~ 69 Cable : S1 ~ S41	
LCD Panel	37" wide TFT LCD panel	
Resolution	WXGA (1366 X 768)	
Power consumption	200W	
Stand by Power consumption	Below 3W	
External antenna impedance	75 Ω	
Audio output	15W + 15W	
External IN/OUT ports	<ul style="list-style-type: none"> • HDMI IN 1 • S-VIDEO IN 1 • COMPONENT IN 1 • SERVICE IN 1 • SPDIF OUT 1 • PC IN 1 • AV IN 2 • ANTENNA IN 1 • PC AUDIO IN 1 	
AC Power	100-240v~, 2.5A-1.5A, 50/60Hz	
Net Weight	37Kg	
Gross Weight	42Kg	

Model	NLT-42HD1	
Main body (With stand)	Horizontal size 1242 mm Height 680(739) mm	Thickness 119(235) mm
Television system	PAL-BG, I, DK / SECAM-BG, DK / NTSC-M	
Television programme	VHF : 0 ~ 11 UHF : 28 ~ 69 Cable : S1 ~ S41	
LCD Panel	42" wide TFT LCD panel	
Resolution	WXGA (1366 X 768)	
Power consumption	240W	
Stand by Power consumption	Below 3W	
External antenna impedance	75 Ω	
Audio output	15W + 15W	
External IN/OUT ports	<ul style="list-style-type: none"> • HDMI IN 1 • S-VIDEO IN 1 • COMPONENT IN 1 • SERVICE IN 1 • SPDIF OUT 1 • PC IN 1 • AV IN 2 • ANTENNA IN 1 • PC AUDIO IN 1 	
AC Power	100-240v~, 2.5A-1.5A, 50/60Hz	
Net Weight	39Kg	
Gross Weight	50Kg	



Note

Note



NEC Australia Pty. Ltd.
ABN 86 001 217 527
Home Electronics Group

NEC Service Centers

PH:131-632

New South Wales

Sydney	184 Milperra Rd, Revesby 2212	131-632
Newcastle	120 Parry Street, Newcastle West 2302	131-632

Victoria

Melbourne	Unit 1/6 Garden Road, Clayton 3168	131-632
-----------	------------------------------------	---------

Queensland

Brisbane	Unit 4/305 Montague Road, West End 4101	131-632
Southport	Shop 1,48 Ferry Road, Southport 4215	131-632

South Australia

Adelaide	84A Richmond Rd, Keswick, 5053	131-632
----------	--------------------------------	---------

Western Australia

Perth	45 Sarich Court, Osborne Park 6017	131-632
-------	------------------------------------	---------

For Service in outer areas, please contact your NEC retailer for the address of the nearest Authorised NEC Service Center.

NEC Australia Pty. Ltd.
Home Electronics Group
244 Beecroft Road EPPING 2121
Tel:131 632
Fax:(02) 9877 2353

P/NO : MAN06GDP018 @
(GPN06MA013B, NEC)